

29276 E

Dimensions

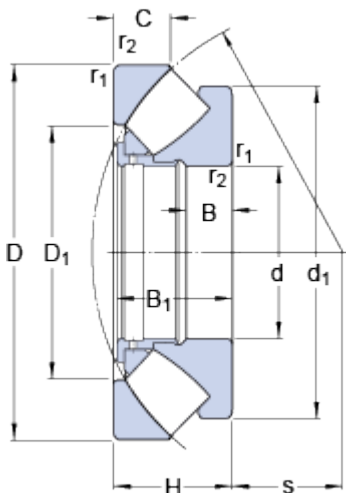

d	380	mm
D	520	mm
H	85	mm
d_1	≈ 505	mm
D_1	≈ 441	mm
B	27	mm
B_1	81	mm
C	42	mm
s	202	mm
$r_{1,2}$	min. 4	mm

Abutment dimensions

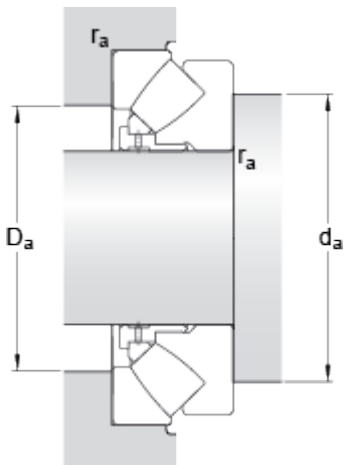

d_a	min. 450	mm
D_a	max. 473	mm
r_a	max. 3	mm

Calculation data

Basic dynamic load rating	C	1580	kN
Basic static load rating	C_0	7650	kN
Fatigue load limit	P_u	655	kN
Reference speed		700	r/min
Limiting speed		1100	r/min
Minimum axial load factor	A	5.6	

Mass

Mass bearing		53	kg
--------------	--	----	----